

SERVICE DATA SHEET

Tiger Sport from VIN 750470

Brakes

- Brake disc maximum run out 0.3 mm front and 0.25 mm rear
- Front brake disc minimum thickness 4.0 mm
- Rear brake disc minimum thickness 5.0 mm
- Brake fluid DOT 4

Master Cylinders

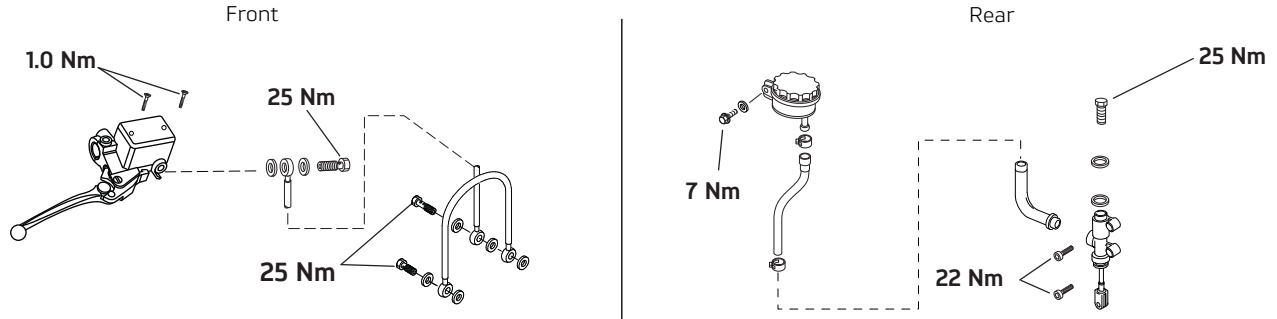

Calipers and Brake Pads

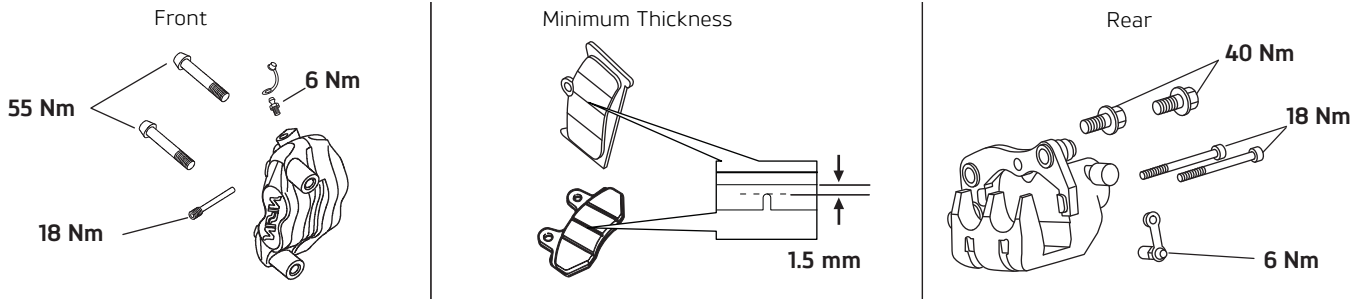

Engine and Lubrication

- Oil Semi or fully synthetic 10W/40 or 10W/50 engine oil which meets specification API SH (or higher) and JASO MA. Triumph recommends Castrol Power 1 Racing 4T 10W/40 or 10W/50 (fully synthetic) engine oil, sold as Castrol Power RS Racing 4T 10W/40 or 10W/50 (fully synthetic) in some countries
- Fill quantity 3.20 litres (oil and filter change). Always refer to the dipstick/filler plug markings for correct level
- Coolant type Triumph HD4X Hybrid OAT coolant (premixed as supplied by Triumph)
- Coolant capacity 2.40 litres
- Grease Grease to NLGI 2 specification
- Camshaft cover bolt Lubricate the seals for the camshaft cover bolts with clean engine oil
- Camshaft cover tightening sequence Tighten the camshaft cover bolts in the sequence shown below. Bolts 1 and 3 are torqued twice, the second time as 7 and 8

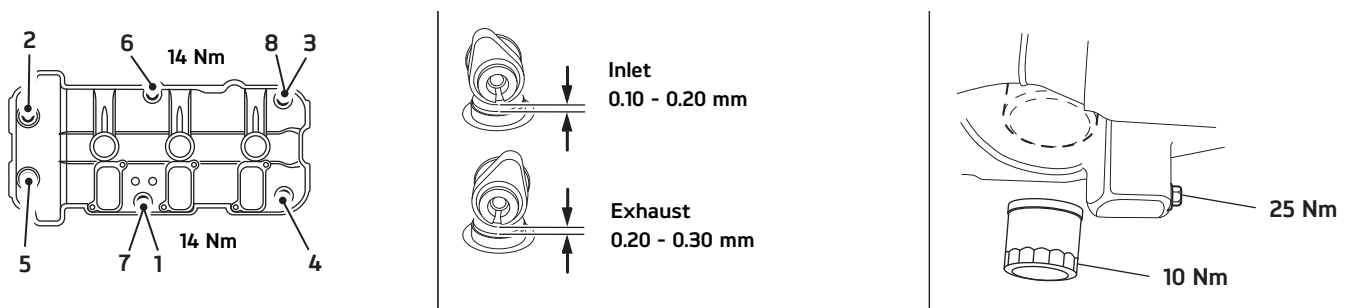

Fuel and Air

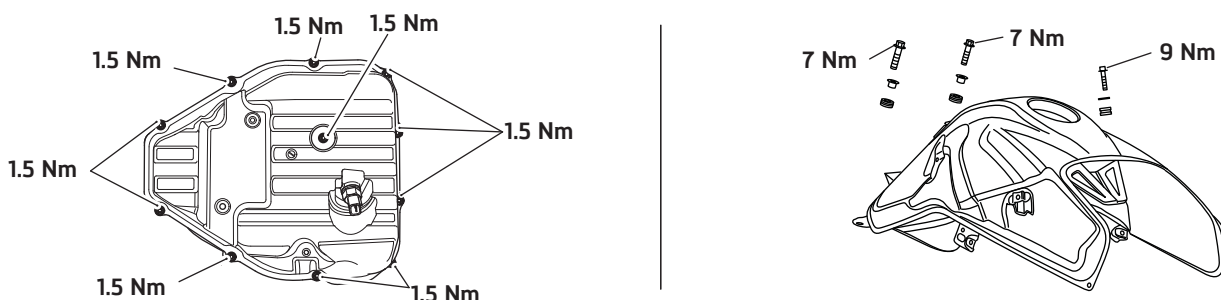

SERVICE DATA SHEET - continued

Final Drive and Clutch

Chain lubrication Chain spray suitable for O-ring chains

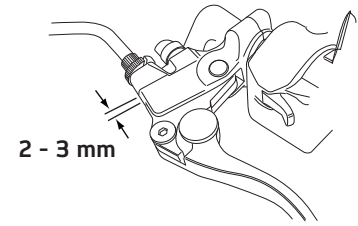
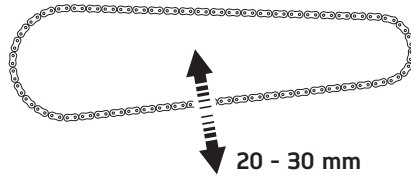
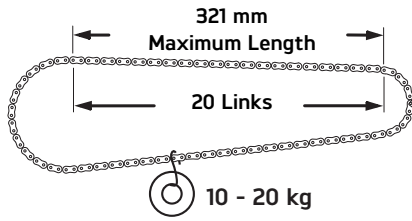

Battery and Ignition

Charge rate Must not exceed 1.2 A (refer to the Service Manual)

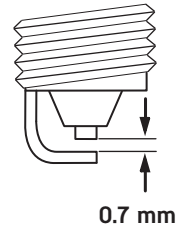
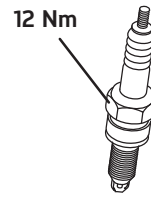
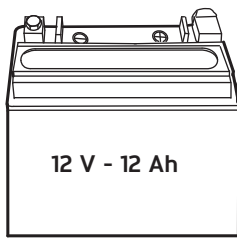

Suspension and Wheels

Recommended fork oil grade
Oil volume (dry fill)
Oil level (fork fully compressed)

Showa SS8 (SAE 10W)
552 cc
85 mm (with spring removed)

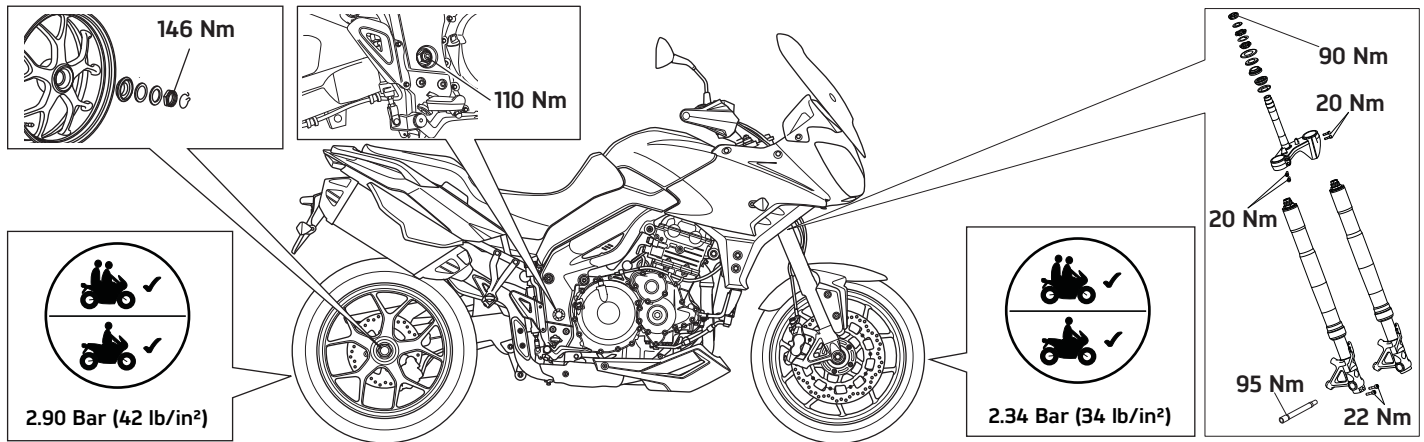

Service Parts Information

Parts Information	Description	Odometer Reading in Miles (km), Time Period				
		500/(800) 1 month	Annual	6,000 (10,000) 18,000 (30,000)	12,000 (20,000)	24,000 (40,000)
For current parts information, refer to the Electronic Parts Catalogue	Sump Plug Washer	•	•	•	•	•
	Oil Filter	•	•	•	•	•
	Air Cleaner				•	•
	Spark Plug				•	•
	Camshaft Cover Seal				•	•
	Camshaft Cover Bolt Seal				•	•
	Front Brake Pad Set			As Necessary		
Rear Brake Pad Set			As Necessary			
Standard Service Time Allowance (Hrs.)		1.25	1.25	2.00	6.00	7.00